

## 54LS125A/DM54LS125A/DM74LS125A Quad TRI-STATE® Buffers

### General Description

This device contains four independent gates each of which performs a non-inverting buffer function. The outputs have the TRI-STATE feature. When enabled, the outputs exhibit the low impedance characteristics of a standard LS output with additional drive capability to permit the driving of bus lines without external resistors. When disabled, both the output transistors are turned off presenting a high-impedance state to the bus line. Thus the output will act neither as a significant load nor as a driver. To minimize the possibility

that two outputs will attempt to take a common bus to opposite logic levels, the disable time is shorter than the enable time of the outputs.

### Features

- Alternate Military/Aerospace device (54LS125) is available. Contact a National Semiconductor Sales Office/Distributor for specifications.

### Connection Diagram

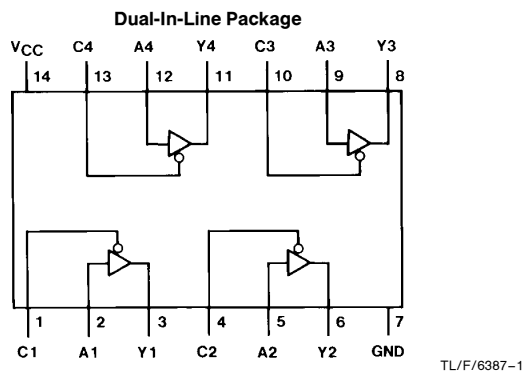

Order Number 54LS125ADMQB, 54LS125AFMQB, 54LS125ALMQB,  
DM54LS125AJ, DM54LS125AW, DM74LS125AM or DM74LS125AN  
See NS Package Number E20A, J14A, M14A, N14A or W14B

### Function Table

$$Y = A$$

Inputs		Output
A	C	Y
L	L	L
H	L	H
X	H	Hi-Z

H = High Logic Level

L = Low Logic Level

X = Either Low or High Logic Level

Hi-Z = TRI-STATE (Outputs are disabled)

TRI-STATE® is a registered trademark of National Semiconductor Corporation.

## Absolute Maximum Ratings (Note)

If Military/Aerospace specified devices are required, please contact the National Semiconductor Sales Office/Distributors for availability and specifications.

Supply Voltage	7V
Input Voltage	7V
Operating Free Air Temperature Range	
DM54LS and 54LS	-55°C to +125°C
DM74LS	0°C to +70°C
Storage Temperature Range	-65°C to +150°C

Note: The "Absolute Maximum Ratings" are those values beyond which the safety of the device cannot be guaranteed. The device should not be operated at these limits. The parametric values defined in the "Electrical Characteristics" table are not guaranteed at the absolute maximum ratings. The "Recommended Operating Conditions" table will define the conditions for actual device operation.

## Recommended Operating Conditions

Symbol	Parameter	DM54LS125A			DM74LS125A			Units
		Min	Nom	Max	Min	Nom	Max	
V <sub>CC</sub>	Supply Voltage	4.5	5	5.5	4.75	5	5.25	V
V <sub>IH</sub>	High Level Input Voltage	2			2			V
V <sub>IL</sub>	Low Level Input Voltage			0.7			0.8	V
I <sub>OH</sub>	High Level Output Current			-1			-2.6	mA
I <sub>OL</sub>	Low Level Output Current			12			24	mA
T <sub>A</sub>	Free Air Operating Temperature	-55		125	0		70	°C

## Electrical Characteristics over recommended operating free air temperature range (unless otherwise noted)

Symbol	Parameter	Conditions	Min	Typ (Note 1)	Max	Units
V <sub>I</sub>	Input Clamp Voltage	V <sub>CC</sub> = Min, I <sub>I</sub> = -18 mA			-1.5	V
V <sub>OH</sub>	High Level Output Voltage	V <sub>CC</sub> = Min, I <sub>OH</sub> = Max V <sub>IL</sub> = Max, V <sub>IH</sub> = Min	2.4	3.4		V
V <sub>OL</sub>	Low Level Output Voltage	V <sub>CC</sub> = Min, I <sub>OL</sub> = Max V <sub>IL</sub> = Max	DM54	0.25	0.4	V
			DM74	0.35	0.5	
		I <sub>OL</sub> = 12 mA, V <sub>CC</sub> = Min	DM74	0.25	0.4	
I <sub>I</sub>	Input Current @ Max Input Voltage	V <sub>CC</sub> = Max, V <sub>I</sub> = 7V			0.1	mA
I <sub>IH</sub>	High Level Input Current	V <sub>CC</sub> = Max, V <sub>I</sub> = 2.7V			20	μA
I <sub>IL</sub>	Low Level Input Current	V <sub>CC</sub> = Max, V <sub>I</sub> = 0.4V			-0.4	mA
I <sub>OZH</sub>	Off-State Output Current with High Level Output Voltage Applied	V <sub>CC</sub> = Max, V <sub>O</sub> = 2.4V V <sub>IH</sub> = Min, V <sub>IL</sub> = Max			20	μA
I <sub>OZL</sub>	Off-State Output Current with Low Level Output Voltage Applied	V <sub>CC</sub> = Max, V <sub>O</sub> = 0.4V V <sub>IH</sub> = Min, V <sub>IL</sub> = Max			-20	μA
I <sub>OS</sub>	Short Circuit Output Current	V <sub>CC</sub> = Max (Note 2)	DM54	-20	-100	mA
			DM74	-20	-100	
I <sub>CC</sub>	Supply Current	V <sub>CC</sub> = Max (Note 3)		11	20	mA

Note 1: All typicals are at V<sub>CC</sub> = 5V, T<sub>A</sub> = 25°C.

Note 2: Not more than one output should be shorted at a time, and the duration should not exceed one second.

Note 3: I<sub>CC</sub> is measured with the data control (C) inputs at 4.5V and the data inputs grounded.

**Switching Characteristics** at  $V_{CC} = 5V$  and  $T_A = 25^\circ C$  (See Section 1 for Test Waveforms and Output Load)

Symbol	Parameter	$R_L = 667\Omega$				Units
		$C_L = 50\text{ pF}$		$C_L = 150\text{ pF}$		
		Min	Max	Min	Max	
$t_{PLH}$	Propagation Delay Time Low to High Level Output		15		21	ns
$t_{PHL}$	Propagation Delay Time High to Low Level Output		18		22	ns
$t_{PZH}$	Output Enable Time to High Level Output		25		35	ns
$t_{PZL}$	Output Enable Time to Low Level Output		25		40	ns
$t_{PHZ}$	Output Disable Time from High Level Output (Note 1)		20			ns
$t_{PLZ}$	Output Disable Time from Low Level Output (Note 1)		20			ns

Note 1:  $C_L = 5\text{ pF}$ .

**Physical Dimensions** inches (millimeters)

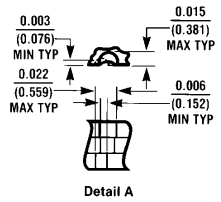
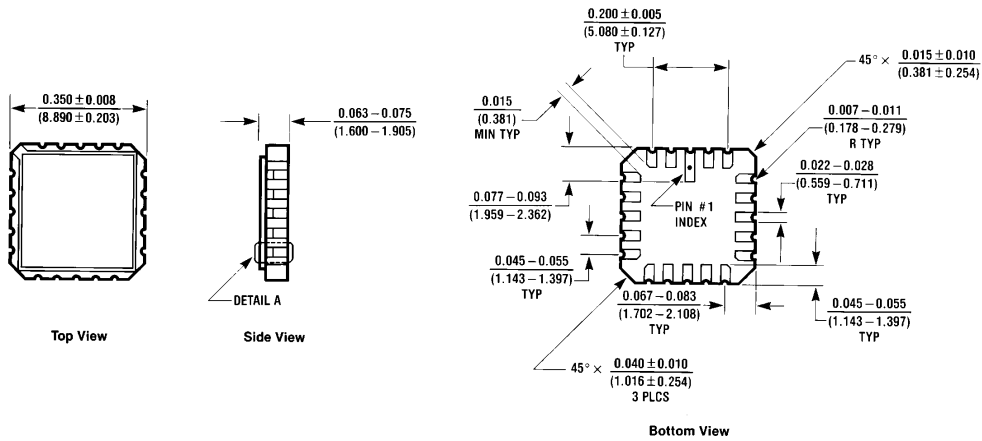

**Ceramic Leadless Chip Carrier Package (E)**  
 Order Number 54LS125ALMQB  
 NS Package Number E20A

E20A (REV D)

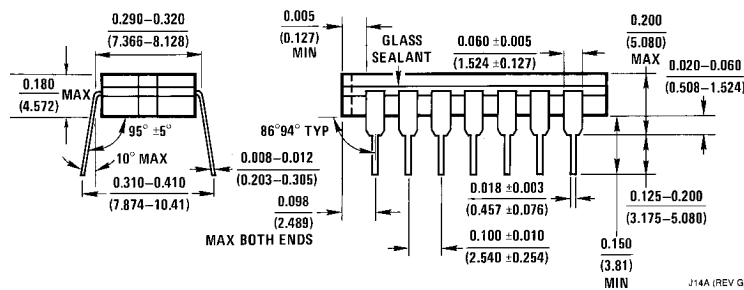
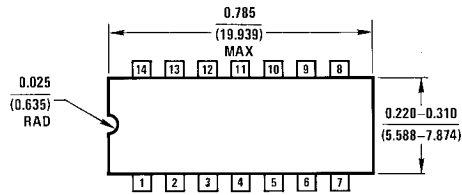

**14-Lead Ceramic Dual-In-Line Package (J)**  
 Order Number 54LS125ADMQB or DM54LS125AJ  
 NS Package Number J14A

J14A (REV G)

**Physical Dimensions** inches (millimeters) (Continued)

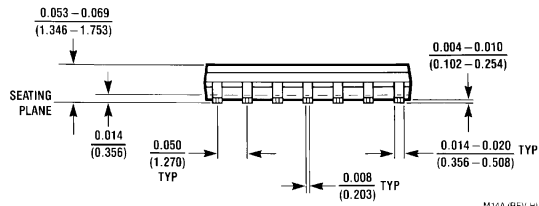
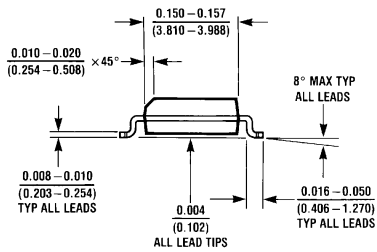
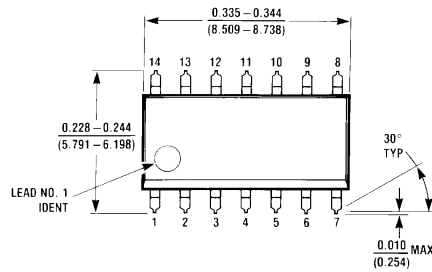

M14A (REV H)

**14-Lead Small Outline Molded Package (M)**  
**Order Number DM74LS125AM**  
**NS Package Number M14A**

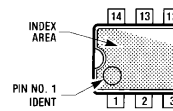
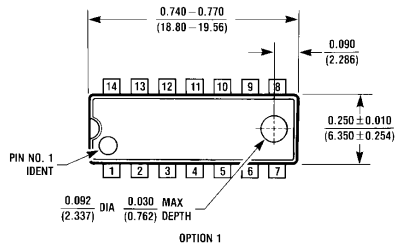

OPTION 1

OPTION D2

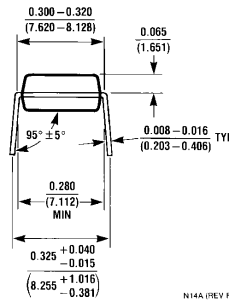
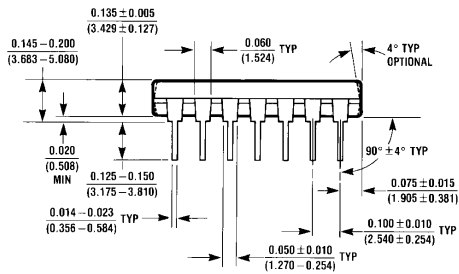

N14A (REV F)

**14-Lead Molded Dual-In-Line Package (N)**  
**Order Number DM74LS125AN**  
**NS Package Number N14A**

**Physical Dimensions** inches (millimeters) (Continued)



**14-Lead Ceramic Flat Package (W)**  
**Order Number 54LS125AFMQB or DM54LS125AW**  
**NS Package Number W14B**

**LIFE SUPPORT POLICY**

NATIONAL'S PRODUCTS ARE NOT AUTHORIZED FOR USE AS CRITICAL COMPONENTS IN LIFE SUPPORT DEVICES OR SYSTEMS WITHOUT THE EXPRESS WRITTEN APPROVAL OF THE PRESIDENT OF NATIONAL SEMICONDUCTOR CORPORATION. As used herein:

1. Life support devices or systems are devices or systems which, (a) are intended for surgical implant into the body, or (b) support or sustain life, and whose failure to perform, when properly used in accordance with instructions for use provided in the labeling, can be reasonably expected to result in a significant injury to the user.
2. A critical component is any component of a life support device or system whose failure to perform can be reasonably expected to cause the failure of the life support device or system, or to affect its safety or effectiveness.



**National Semiconductor Corporation**  
 1111 West Bardin Road  
 Arlington, TX 76017  
 Tel: 1(800) 272-9959  
 Fax: 1(800) 737-7018

**National Semiconductor Europe**  
 Fax: (+49) 0-180-530 85 86  
 Email: cnjwge@tevm2.nsc.com  
 Deutsch Tel: (+49) 0-180-530 85 85  
 English Tel: (+49) 0-180-532 78 32  
 Français Tel: (+49) 0-180-532 93 58  
 Italiano Tel: (+49) 0-180-534 16 80

**National Semiconductor Hong Kong Ltd.**  
 19th Floor, Straight Block,  
 Ocean Centre, 5 Canton Rd.  
 Tsimshatsui, Kowloon  
 Hong Kong  
 Tel: (852) 2737-1600  
 Fax: (852) 2736-9960

**National Semiconductor Japan Ltd.**  
 Tel: 81-043-299-2309  
 Fax: 81-043-299-2408

National does not assume any responsibility for use of any circuitry described, no circuit patent licenses are implied and National reserves the right at any time without notice to change said circuitry and specifications.