

# NTR4101P, NTRV4101P

## Trench Power MOSFET –20 V, Single P–Channel, SOT–23

### Features

- Leading –20 V Trench for Low  $R_{DS(on)}$
- –1.8 V Rated for Low Voltage Gate Drive
- SOT–23 Surface Mount for Small Footprint
- NTRV Prefix for Automotive and Other Applications Requiring Unique Site and Control Change Requirements; AEC–Q101 Qualified and PPAP Capable
- These Devices are Pb–Free, Halogen Free/BFR Free and are RoHS Compliant

### Applications

- Load/Power Management for Portables
- Load/Power Management for Computing
- Charging Circuits and Battery Protection

### MAXIMUM RATINGS ( $T_J = 25^\circ\text{C}$ unless otherwise noted)

Parameter		Symbol	Value	Unit	
Drain–to–Source Voltage		$V_{DSS}$	–20	V	
Gate–to–Source Voltage		$V_{GS}$	$\pm 8.0$	V	
Continuous Drain Current (Note 1)	Steady State	$T_A = 25^\circ\text{C}$	$I_D$	–2.4	A
		$T_A = 85^\circ\text{C}$		–1.7	
	$t \leq 10$ s	$T_A = 25^\circ\text{C}$		–3.2	
Power Dissipation (Note 1)	Steady State	$T_A = 25^\circ\text{C}$	$P_D$	0.73	W
				1.25	
Continuous Drain Current (Note 2)	Steady State	$T_A = 25^\circ\text{C}$	$I_D$	–1.8	A
		$T_A = 85^\circ\text{C}$		–1.3	
		$T_A = 25^\circ\text{C}$	$P_D$	0.42	W
Power Dissipation (Note 2)					
Pulsed Drain Current	$t_p = 10$ $\mu\text{s}$	$I_{DM}$	–18	A	
ESD Capability (Note 3)	$C = 100$ pF, $R_S = 1500$ $\Omega$	ESD	225	V	
Operating Junction and Storage Temperature		$T_J$ , $T_{STG}$	–55 to 150	$^\circ\text{C}$	
Source Current (Body Diode)		$I_S$	–2.4	A	
Single Pulse Drain–to–Source Avalanche Energy ( $V_{GS} = -8$ V, $I_L = -1.8$ Apk, $L = 10$ mH, $R_G = 25$ $\Omega$ )		EAS	16	mJ	
Lead Temperature for Soldering Purposes (1/8" from case for 10 s)		$T_L$	260	$^\circ\text{C}$	

Stresses exceeding those listed in the Maximum Ratings table may damage the device. If any of these limits are exceeded, device functionality should not be assumed, damage may occur and reliability may be affected.



ON Semiconductor®

[www.onsemi.com](http://www.onsemi.com)

$V_{(BR)DSS}$	$R_{DS(ON)}$ TYP	$I_D$ MAX
–20 V	70 m $\Omega$ @ –4.5 V	–3.2 A
	90 m $\Omega$ @ –2.5 V	
	112 m $\Omega$ @ –1.8 V	

### P–Channel MOSFET

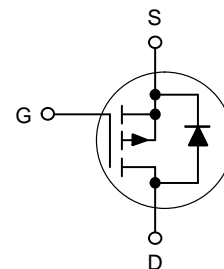

### MARKING DIAGRAM & PIN ASSIGNMENT

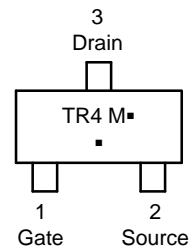
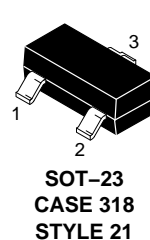

TR4 = Device Code  
M = Date Code  
▪ = Pb–Free Package

(Note: Microdot may be in either location)

### ORDERING INFORMATION

Device	Package	Shipping†
NTR4101PT1G	SOT–23 (Pb–Free)	3000 / Tape & Reel
NTRV4101PT1G		

†For information on tape and reel specifications, including part orientation and tape sizes, please refer to our Tape and Reel Packaging Specifications Brochure, BRD8011/D.

# NTR4101P, NTRV4101P

## THERMAL RESISTANCE RATINGS

Parameter	Symbol	Max	Unit
Junction-to-Ambient – Steady State (Note 1)	$R_{\theta JA}$	170	°C/W
Junction-to-Ambient – $t < 10$ s (Note 1)	$R_{\theta JA}$	100	
Junction-to-Ambient – Steady State (Note 2)	$R_{\theta JA}$	300	

- Surface-mounted on FR4 board using 1 in sq pad size (Cu area = 1.127 in sq [1 oz] including traces)
- Surface-mounted on FR4 board using the minimum recommended pad size.
- ESD Rating Information: HBM Class 0

## ELECTRICAL CHARACTERISTICS ( $T_A = 25^\circ\text{C}$ unless otherwise noted)

Characteristic	Symbol	Min	Typ	Max	Unit
----------------	--------	-----	-----	-----	------

### OFF CHARACTERISTICS

Drain-to-Source Breakdown Voltage (Note 4) ( $V_{GS} = 0$ V, $I_D = -250$ $\mu\text{A}$ )	$V_{(BR)DSS}$	-20			V
Zero Gate Voltage Drain Current (Note 4) ( $V_{GS} = 0$ V, $V_{DS} = -16$ V)	$I_{DSS}$			-1.0	$\mu\text{A}$
Gate-to-Source Leakage Current ( $V_{GS} = \pm 8.0$ V, $V_{DS} = 0$ V)	$I_{GSS}$			$\pm 100$	nA

### ON CHARACTERISTICS

Gate Threshold Voltage (Note 4) ( $V_{GS} = V_{DS}$ , $I_D = -250$ $\mu\text{A}$ )	$V_{GS(th)}$	-0.4	-0.72	-1.2	V
Drain-to-Source On-Resistance ( $V_{GS} = -4.5$ V, $I_D = -1.6$ A) ( $V_{GS} = -2.5$ V, $I_D = -1.3$ A) ( $V_{GS} = -1.8$ V, $I_D = -0.9$ A)	$R_{DS(on)}$		70 90 112	85 120 210	m $\Omega$
Forward Transconductance ( $V_{DS} = -5.0$ V, $I_D = -2.3$ A)	$g_{FS}$		7.5		S

### CHARGES, CAPACITANCES & GATE RESISTANCE

Input Capacitance	$(V_{GS} = 0$ V, $f = 1$ MHz, $V_{DS} = -10$ V)	$C_{iss}$	675		pF
Output Capacitance		$C_{oss}$	100		
Reverse Transfer Capacitance		$C_{rss}$	75		
Total Gate Charge	$(V_{GS} = -4.5$ V, $V_{DS} = -10$ V, $I_D = -1.6$ A)	$Q_{G(tot)}$	7.5	8.5	nC
Gate-to-Source Gate Charge	$(V_{DS} = -10$ V, $I_D = -1.6$ A)	$Q_{GS}$	1.2		nC
Gate-to-Drain "Miller" Charge	$(V_{DS} = -10$ V, $I_D = -1.6$ A)	$Q_{GD}$	2.2		nC
Gate Resistance		$R_G$	6.5		$\Omega$

### SWITCHING CHARACTERISTICS (Note 5)

Turn-On Delay Time	$(V_{GS} = -4.5$ V, $V_{DS} = -10$ V, $I_D = -1.6$ A, $R_G = 6.0$ $\Omega$ )	$t_{d(on)}$	7.5		ns
Rise Time		$t_r$	12.6		
Turn-Off Delay Time		$t_{d(off)}$	30.2		
Fall Time		$t_f$	21.0		

### DRAIN-SOURCE DIODE CHARACTERISTICS

Forward Diode Voltage	$(V_{GS} = 0$ V, $I_S = -2.4$ A)	$V_{SD}$		-0.82	-1.2	V
Reverse Recovery Time	$(V_{GS} = 0$ V, $dI_{SD}/dt = 100$ A/ $\mu\text{s}$ , $I_S = -1.6$ A)	$t_{rr}$		12.8	15	ns
Charge Time		$t_a$		9.9		ns
Discharge Time		$t_b$		3.0		ns
Reverse Recovery Charge		$Q_{rr}$		1008		nC

Product parametric performance is indicated in the Electrical Characteristics for the listed test conditions, unless otherwise noted. Product performance may not be indicated by the Electrical Characteristics if operated under different conditions.

- Pulse Test: Pulse Width  $\leq 300$   $\mu\text{s}$ , Duty Cycle  $\leq 2\%$ .
- Switching characteristics are independent of operating junction temperature.

# NTR4101P, NTRV4101P

## TYPICAL PERFORMANCE CURVES ( $T_J = 25^\circ\text{C}$ unless otherwise noted)

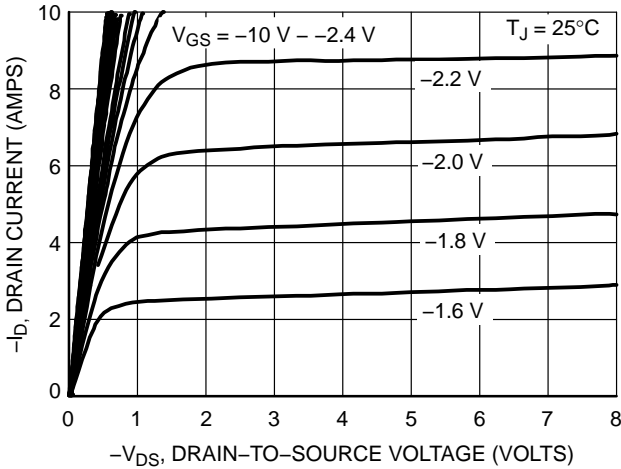

Figure 1. On-Region Characteristics

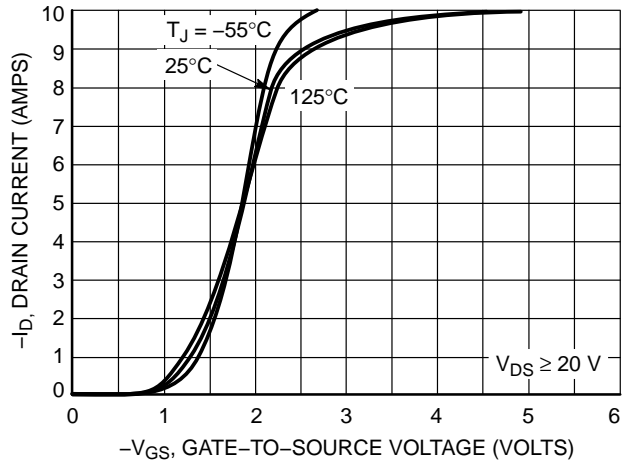

Figure 2. Transfer Characteristics

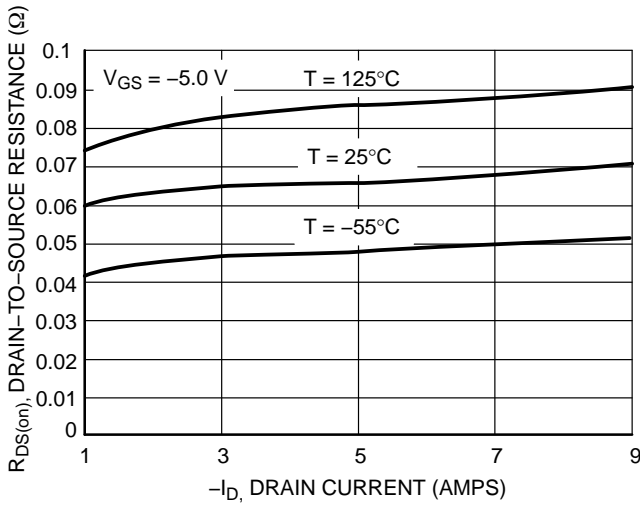

Figure 3. On-Resistance vs. Drain Current and Temperature

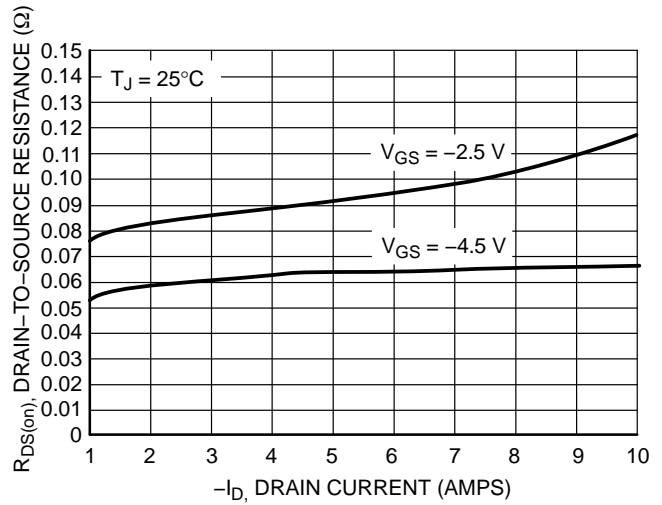

Figure 4. On-Resistance vs. Drain Current and Temperature

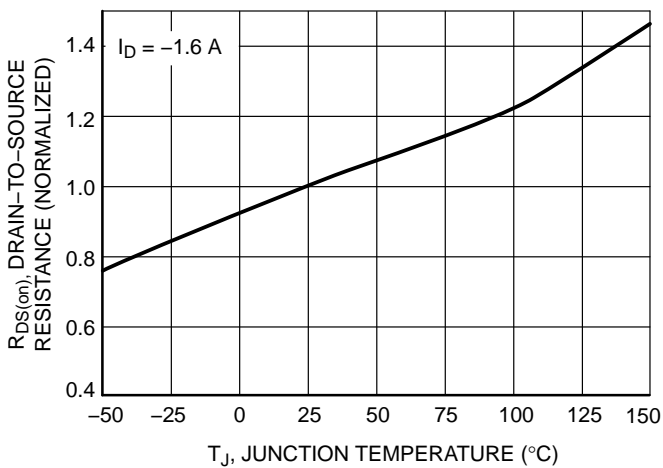

Figure 5. On-Resistance Variation with Temperature

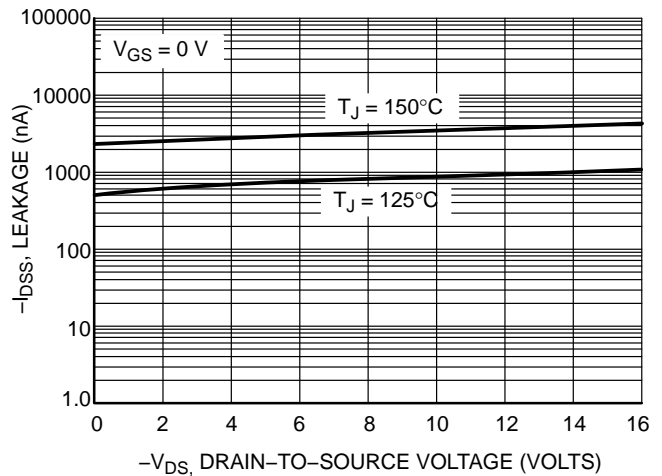

Figure 6. Drain-to-Source Leakage Current vs. Voltage

# NTR4101P, NTRV4101P

## TYPICAL PERFORMANCE CURVES ( $T_J = 25^\circ\text{C}$ unless otherwise noted)

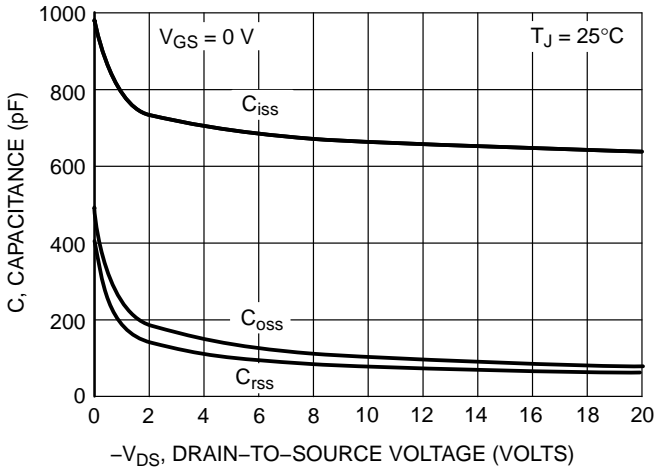

Figure 7. Capacitance Variation

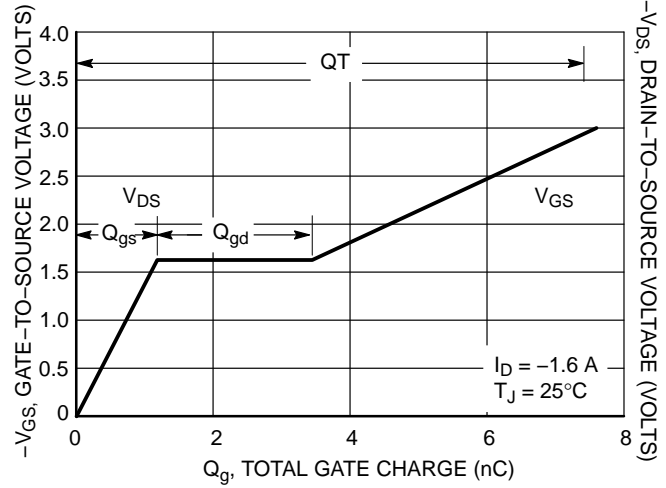

Figure 8. Gate-to-Source and Drain-to-Source Voltage vs. Total Gate Charge

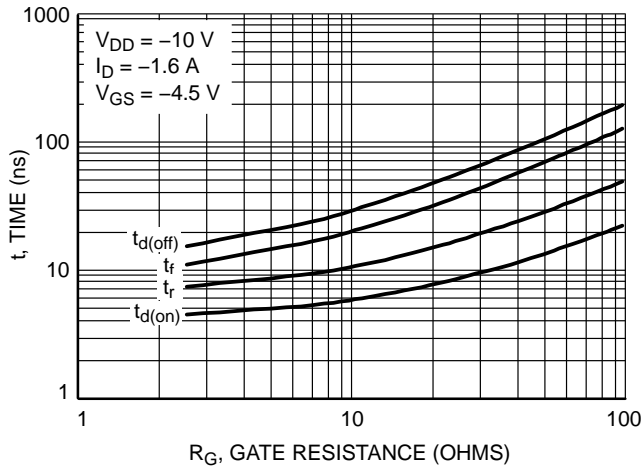

Figure 9. Resistive Switching Time Variation vs. Gate Resistance

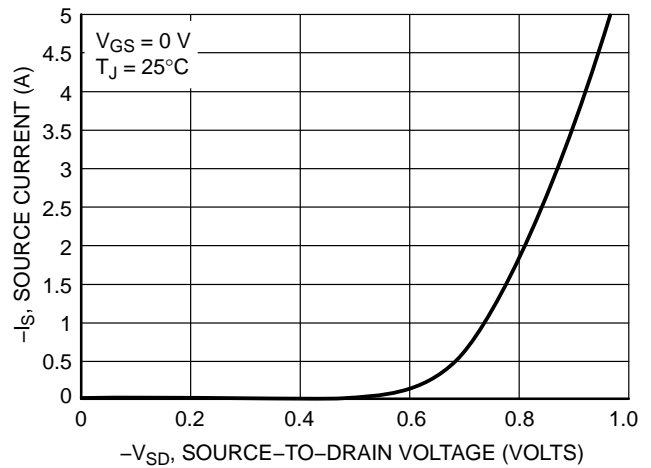

Figure 10. Diode Forward Voltage vs. Current

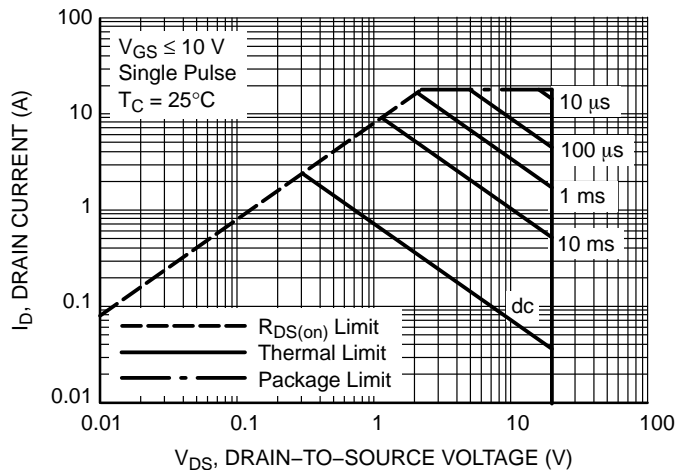
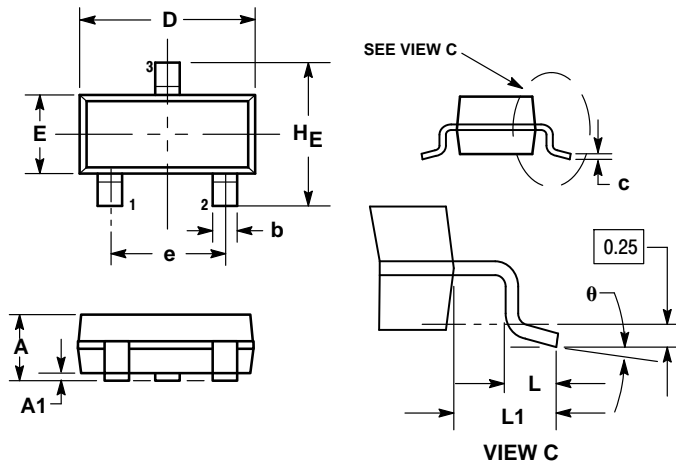

Figure 11. Maximum Rated Forward Biased Safe Operating Area

# NTR4101P, NTRV4101P

## PACKAGE DIMENSIONS

SOT-23 (TO-236)  
CASE 318-08  
ISSUE AP



NOTES:

1. DIMENSIONING AND TOLERANCING PER ANSI Y14.5M, 1982.
2. CONTROLLING DIMENSION: INCH.
3. MAXIMUM LEAD THICKNESS INCLUDES LEAD FINISH THICKNESS. MINIMUM LEAD THICKNESS IS THE MINIMUM THICKNESS OF BASE MATERIAL.
4. DIMENSIONS D AND E DO NOT INCLUDE MOLD FLASH,

DIM	MILLIMETERS			INCHES		
	MIN	NOM	MAX	MIN	NOM	MAX
A	0.89	1.00	1.11	0.035	0.040	0.044
A1	0.01	0.06	0.10	0.001	0.002	0.004
b	0.37	0.44	0.50	0.015	0.018	0.020
c	0.09	0.13	0.18	0.003	0.005	0.007
D	2.80	2.90	3.04	0.110	0.114	0.120
E	1.20	1.30	1.40	0.047	0.051	0.055
e	1.78	1.90	2.04	0.070	0.075	0.081
L	0.10	0.20	0.30	0.004	0.008	0.012
L1	0.35	0.54	0.69	0.014	0.021	0.029
HE	2.10	2.40	2.64	0.083	0.094	0.104
θ	0°	---	10°	0°	---	10°

STYLE 12:

1. CATHODE
2. CATHODE
3. ANODE

### SOLDERING FOOTPRINT\*

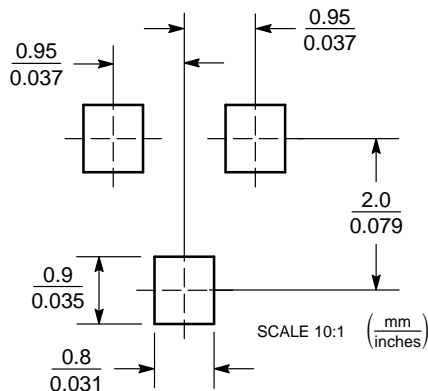

\*For additional information on our Pb-Free strategy and soldering details, please download the ON Semiconductor Soldering and Mounting Techniques Reference Manual, SOLDERRM/D.

ON Semiconductor and the  are registered trademarks of Semiconductor Components Industries, LLC (SCILLC) or its subsidiaries in the United States and/or other countries. SCILLC owns the rights to a number of patents, trademarks, copyrights, trade secrets, and other intellectual property. A listing of SCILLC's product/patent coverage may be accessed at [www.onsemi.com/site/pdf/Patent-Marking.pdf](http://www.onsemi.com/site/pdf/Patent-Marking.pdf). SCILLC reserves the right to make changes without further notice to any products herein. SCILLC makes no warranty, representation or guarantee regarding the suitability of its products for any particular purpose, nor does SCILLC assume any liability arising out of the application or use of any product or circuit, and specifically disclaims any and all liability, including without limitation special, consequential or incidental damages. "Typical" parameters which may be provided in SCILLC data sheets and/or specifications can and do vary in different applications and actual performance may vary over time. All operating parameters, including "Typicals" must be validated for each customer application by customer's technical experts. SCILLC does not convey any license under its patent rights nor the rights of others. SCILLC products are not designed, intended, or authorized for use as components in systems intended for surgical implant into the body, or other applications intended to support or sustain life, or for any other application in which the failure of the SCILLC product could create a situation where personal injury or death may occur. Should Buyer purchase or use SCILLC products for any such unintended or unauthorized application, Buyer shall indemnify and hold SCILLC and its officers, employees, subsidiaries, affiliates, and distributors harmless against all claims, costs, damages, and expenses, and reasonable attorney fees arising out of, directly or indirectly, any claim of personal injury or death associated with such unintended or unauthorized use, even if such claim alleges that SCILLC was negligent regarding the design or manufacture of the part. SCILLC is an Equal Opportunity/Affirmative Action Employer. This literature is subject to all applicable copyright laws and is not for resale in any manner.

### PUBLICATION ORDERING INFORMATION

**LITERATURE FULFILLMENT:**

Literature Distribution Center for ON Semiconductor  
P.O. Box 5163, Denver, Colorado 80217 USA  
Phone: 303-675-2175 or 800-344-3860 Toll Free USA/Canada  
Fax: 303-675-2176 or 800-344-3867 Toll Free USA/Canada  
Email: [orderlit@onsemi.com](mailto:orderlit@onsemi.com)

**N. American Technical Support:** 800-282-9855 Toll Free  
USA/Canada  
**Europe, Middle East and Africa Technical Support:**  
Phone: 421 33 790 2910  
**Japan Customer Focus Center**  
Phone: 81-3-5817-1050

**ON Semiconductor Website:** [www.onsemi.com](http://www.onsemi.com)  
**Order Literature:** <http://www.onsemi.com/orderlit>

For additional information, please contact your local Sales Representative