

LM78XX Series Voltage Regulators

 Check for Samples: [LM7805C](#), [LM7812C](#), [LM7815C](#)

FEATURES

- Output Current in Excess of 1A
- Internal Thermal Overload Protection
- No External Components Required
- Output Transistor Safe Area Protection
- Internal Short Circuit Current Limit
- Available in the Aluminum TO-3 Package

DESCRIPTION

The LM78XX series of three terminal regulators is available with several fixed output voltages making them useful in a wide range of applications. One of these is local on card regulation, eliminating the distribution problems associated with single point regulation. The voltages available allow these regulators to be used in logic systems, instrumentation, HiFi, and other solid state electronic equipment. Although designed primarily as fixed voltage regulators these devices can be used with external components to obtain adjustable voltages and currents.

The LM78XX series is available in an aluminum TO-3 package which will allow over 1.0A load current if adequate heat sinking is provided. Current limiting is included to limit the peak output current to a safe value. Safe area protection for the output transistor is provided to limit internal power dissipation. If internal power dissipation becomes too high for the heat sinking provided, the thermal shutdown circuit takes over preventing the IC from overheating.

Considerable effort was expended to make the LM78XX series of regulators easy to use and minimize the number of external components. It is not necessary to bypass the output, although this does improve transient response. Input bypassing is needed only if the regulator is located far from the filter capacitor of the power supply.

For output voltage other than 5V, 12V and 15V the LM117 series provides an output voltage range from 1.2V to 57V.

VOLTAGE RANGE

- **LM7805C: 5V**
- **LM7812C: 12V**
- **LM7815C: 15V**

Connection Diagrams

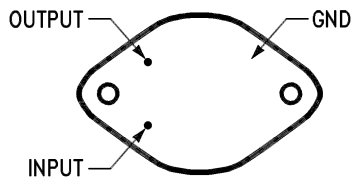

**Figure 1. Metal Can Package
TO-3
Aluminum
Bottom View**

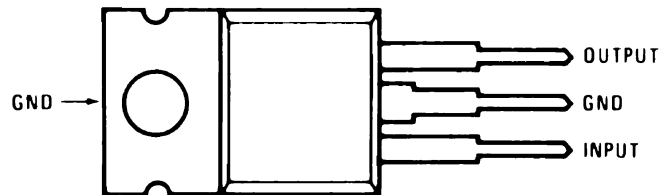

**Figure 2. Plastic Package
TO-220 (NDE)
Top View
See Package Number NDE0003B**



Please be aware that an important notice concerning availability, standard warranty, and use in critical applications of Texas Instruments semiconductor products and disclaimers thereto appears at the end of this data sheet.

All trademarks are the property of their respective owners.

SCHEMATIC DIAGRAM

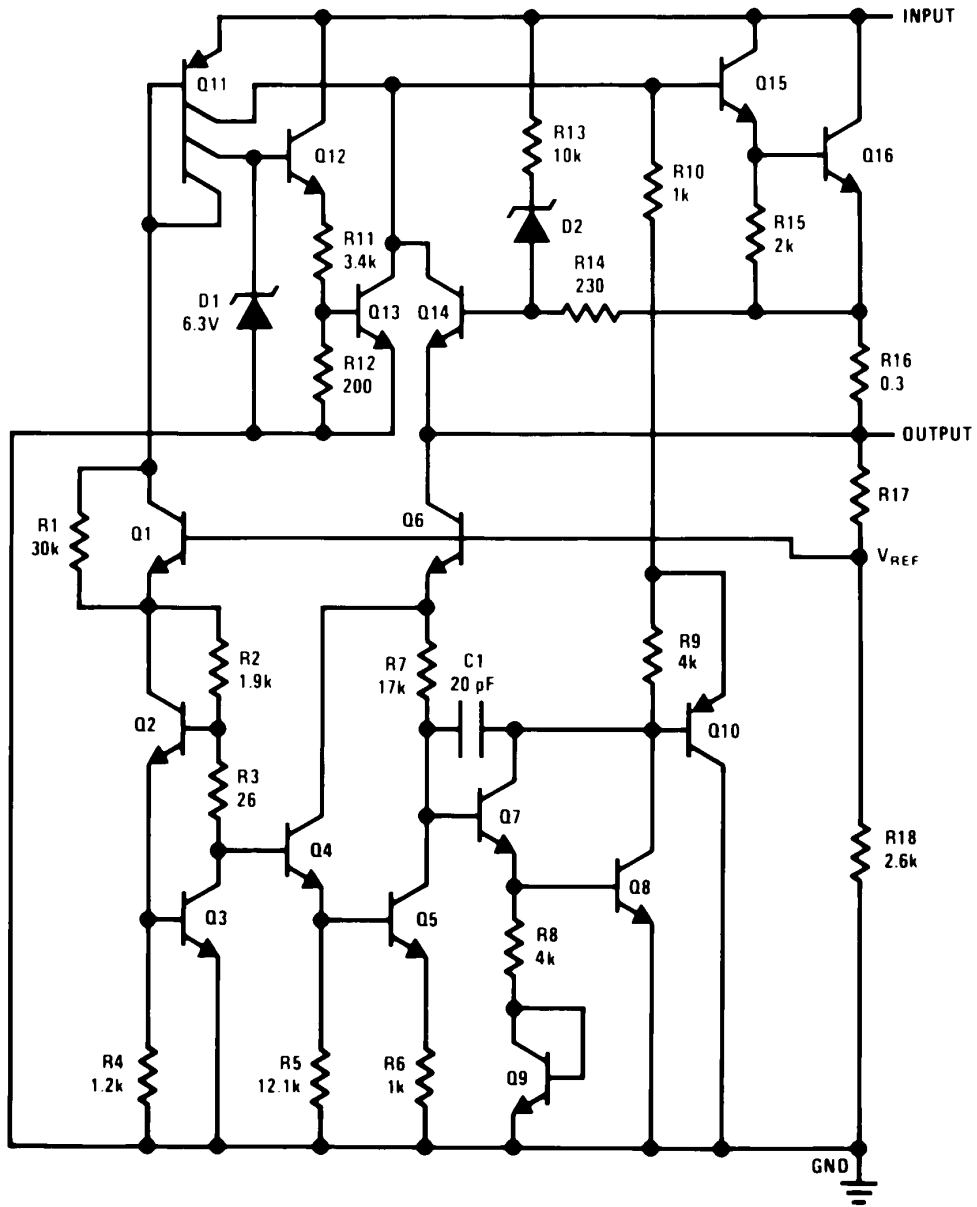



These devices have limited built-in ESD protection. The leads should be shorted together or the device placed in conductive foam during storage or handling to prevent electrostatic damage to the MOS gates.

ABSOLUTE MAXIMUM RATINGS⁽¹⁾⁽²⁾

Input Voltage ($V_O = 5V, 12V$ and $15V$)		35V
Internal Power Dissipation ⁽³⁾		Internally Limited
Operating Temperature Range (T_A)		0°C to +70°C
Maximum Junction Temperature	(TO-3 Package)	150°C
	(NDE Package)	150°C
Storage Temperature Range		-65°C to +150°C
Lead Temperature (Soldering, 10 sec.)	TO-3 Package	300°C
	TO-220 Package NDE	230°C

- (1) Absolute Maximum Ratings indicate limits beyond which damage to the device may occur. For ensured specifications and the test conditions, see Electrical Characteristics.
- (2) If Military/Aerospace specified devices are required, please contact the Texas Instruments Sales Office/Distributors for availability and specifications.
- (3) Thermal resistance of the TO-3 package is typically 4°C/W junction to case and 35°C/W case to ambient. Thermal resistance of the TO-220 package (NDE) is typically 4°C/W junction to case and 50°C/W case to ambient.

ELECTRICAL CHARACTERISTICS LM78XXC⁽¹⁾

0°C ≤ T_J ≤ 125°C unless otherwise noted.

Output Voltage			5V			12V			15V			Units		
Input Voltage (unless otherwise noted)			10V			19V			23V					
Symbol	Parameter	Conditions	Min	Typ	Max	Min	Typ	Max	Min	Typ	Max			
V_O	Output Voltage	$T_J = 25^\circ\text{C}, 5\text{ mA} \leq I_O \leq 1\text{ A}$	4.8	5	5.2	11.5	12	12.5	14.4	15	15.6	V		
		$P_D \leq 15\text{ W}, 5\text{ mA} \leq I_O \leq 1\text{ A}$	4.75		5.25	11.4		12.6	14.2		15.7	V		
		$V_{\text{MIN}} \leq V_{\text{IN}} \leq V_{\text{MAX}}$			(7.5 ≤ $V_{\text{IN}} \leq 20$)			(14.5 ≤ $V_{\text{IN}} \leq 27$)			(17.5 ≤ $V_{\text{IN}} \leq 30$)	V		
ΔV_O	Line Regulation	$I_O = 500\text{ mA}$	$T_J = 25^\circ\text{C}$	3	50	4	120	4	150	mV				
			ΔV_{IN}		(7 ≤ $V_{\text{IN}} \leq 25$)		(14.5 ≤ $V_{\text{IN}} \leq 30$)		(17.5 ≤ $V_{\text{IN}} \leq 30$)	V				
			$0^\circ\text{C} \leq T_J \leq +125^\circ\text{C}$		50		120		150	mV				
		$I_O \leq 1\text{ A}$	ΔV_{IN}		(8 ≤ $V_{\text{IN}} \leq 20$)		(15 ≤ $V_{\text{IN}} \leq 27$)		(18.5 ≤ $V_{\text{IN}} \leq 30$)	V				
			$T_J = 25^\circ\text{C}$		50		120		150	mV				
			ΔV_{IN}		(7.5 ≤ $V_{\text{IN}} \leq 20$)		(14.6 ≤ $V_{\text{IN}} \leq 27$)		(17.7 ≤ $V_{\text{IN}} \leq 30$)	V				
ΔV_O	Load Regulation	$T_J = 25^\circ\text{C}$	$5\text{ mA} \leq I_O \leq 1.5\text{ A}$		10	50		12	120	12	150	mV		
			$250\text{ mA} \leq I_O \leq 750\text{ mA}$			25			60			75	mV	
		$5\text{ mA} \leq I_O \leq 1\text{ A}, 0^\circ\text{C} \leq T_J \leq +125^\circ\text{C}$			50			120			150	mV		
I_Q	Quiescent Current	$I_O \leq 1\text{ A}$	$T_J = 25^\circ\text{C}$			8			8			8	mA	
			$0^\circ\text{C} \leq T_J \leq +125^\circ\text{C}$			8.5			8.5			8.5	mA	
ΔI_Q	Quiescent Current Change	$5\text{ mA} \leq I_O \leq 1\text{ A}$				0.5			0.5			0.5	mA	
		$T_J = 25^\circ\text{C}, I_O \leq 1\text{ A}$					1.0			1.0			1.0	mA
			$V_{\text{MIN}} \leq V_{\text{IN}} \leq V_{\text{MAX}}$				(7.5 ≤ $V_{\text{IN}} \leq 20$)			(14.8 ≤ $V_{\text{IN}} \leq 27$)			(17.9 ≤ $V_{\text{IN}} \leq 30$)	V
		$I_O \leq 500\text{ mA}, 0^\circ\text{C} \leq T_J \leq +125^\circ\text{C}$				1.0			1.0			1.0	mA	
$V_{\text{MIN}} \leq V_{\text{IN}} \leq V_{\text{MAX}}$				(7 ≤ $V_{\text{IN}} \leq 25$)			(14.5 ≤ $V_{\text{IN}} \leq 30$)			(17.5 ≤ $V_{\text{IN}} \leq 30$)	V			

- (1) All characteristics are measured with capacitor across the input of 0.22 μF, and a capacitor across the output of 0.1 μF. All characteristics except noise voltage and ripple rejection ratio are measured using pulse techniques ($t_w \leq 10\text{ ms}$, duty cycle ≤ 5%). Output voltage changes due to changes in internal temperature must be taken into account separately.

ELECTRICAL CHARACTERISTICS LM78XXC⁽¹⁾ (continued)0°C ≤ T_J ≤ 125°C unless otherwise noted.

Output Voltage			5V			12V			15V			Units
Input Voltage (unless otherwise noted)			10V			19V			23V			
Symbol	Parameter	Conditions	Min	Typ	Max	Min	Typ	Max	Min	Typ	Max	
V _N	Output Noise Voltage	T _A = 25°C, 10 Hz ≤ f ≤ 100 kHz		40			75			90		μV
ΔV _{IN} /ΔV _{OUT}	Ripple Rejection	f = 120 Hz I _O ≤ 1A, T _J = 25°C or I _O ≤ 500 mA 0°C ≤ T _J ≤ +125°C	62	80		55	72		54	70		dB
			62			55			54			dB
		V _{MIN} ≤ V _{IN} ≤ V _{MAX}	(8 ≤ V _{IN} ≤ 18)			(15 ≤ V _{IN} ≤ 25)			(18.5 ≤ V _{IN} ≤ 28.5)			V
R _O	Dropout Voltage	T _J = 25°C, I _{OUT} = 1A		2.0			2.0			2.0		V
	Output Resistance	f = 1 kHz		8			18			19		mΩ
	Short-Circuit Current	T _J = 25°C		2.1			1.5			1.2		A
	Peak Output Current	T _J = 25°C		2.4			2.4			2.4		A
	Average TC of V _{OUT}	0°C ≤ T _J ≤ +125°C, I _O = 5 mA		0.6			1.5			1.8		mV/°C
V _{IN}	Input Voltage Required to Maintain Line Regulation	T _J = 25°C, I _O ≤ 1A		7.5		14.6			17.7			V

TYPICAL PERFORMANCE CHARACTERISTICS

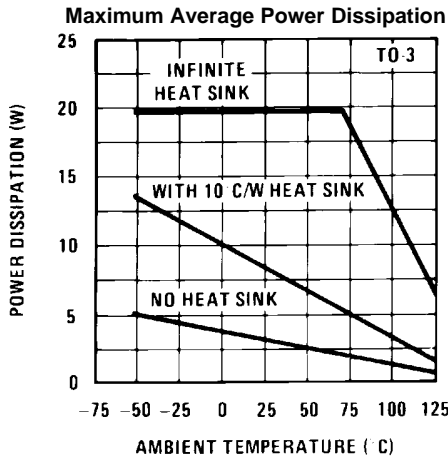

Figure 3.

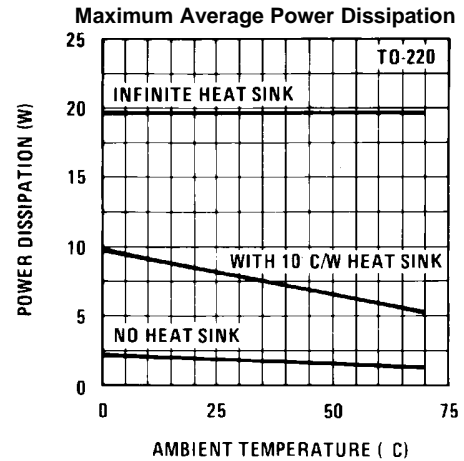

Figure 4.

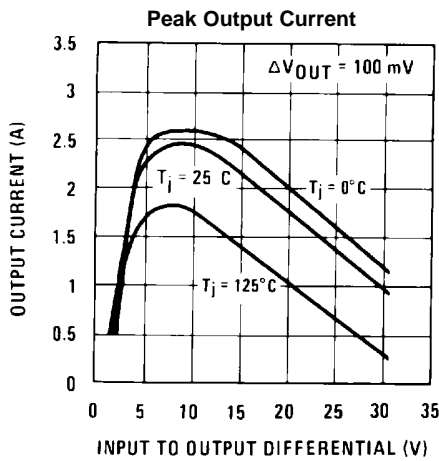

Figure 5.

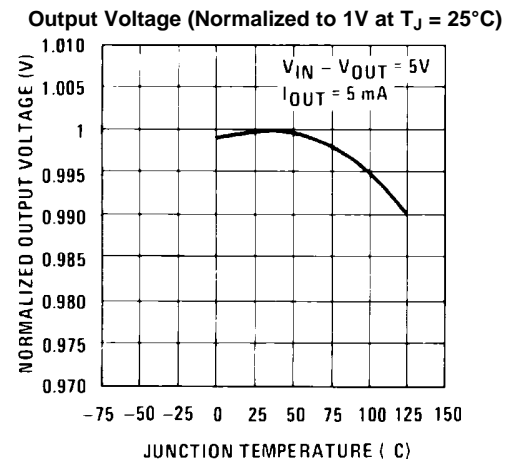

Figure 6.

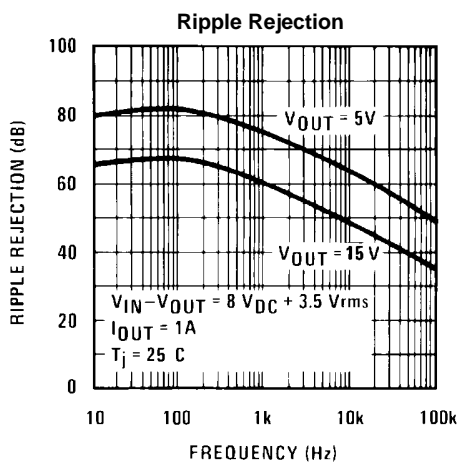

Figure 7.

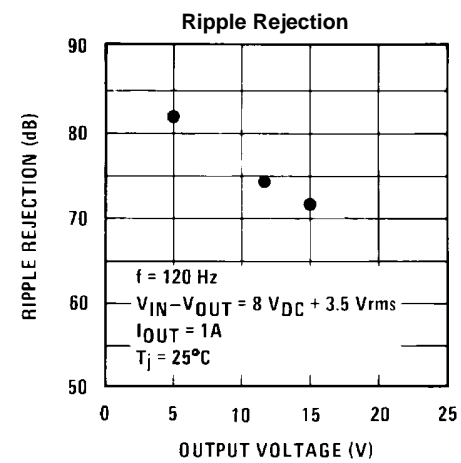
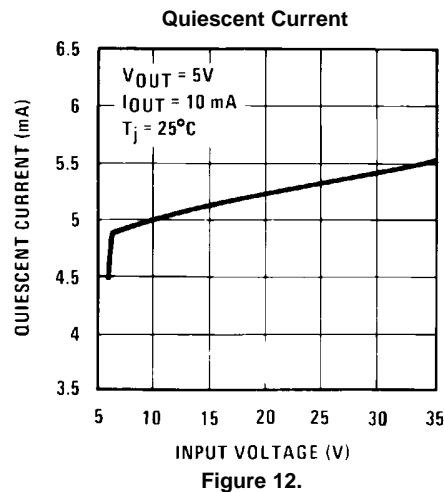
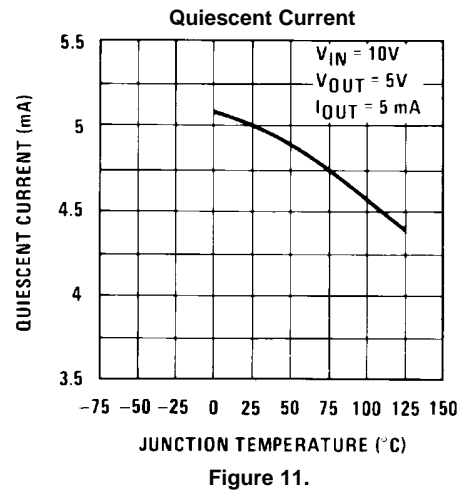
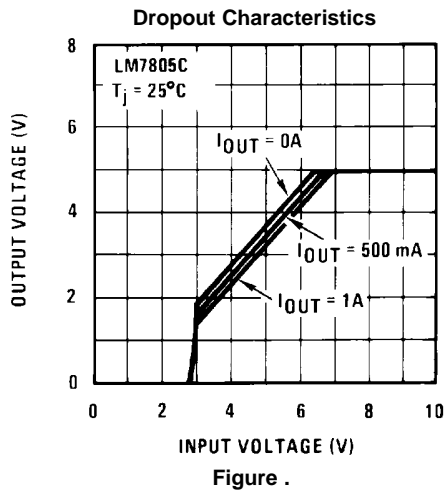
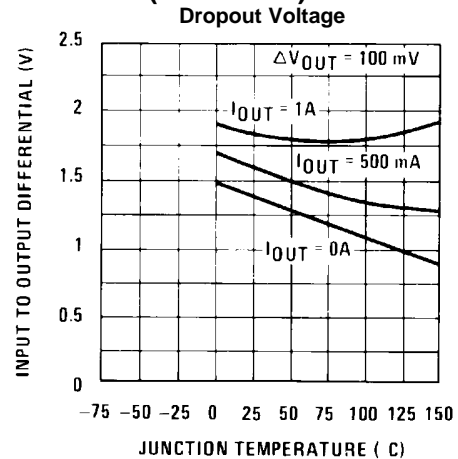
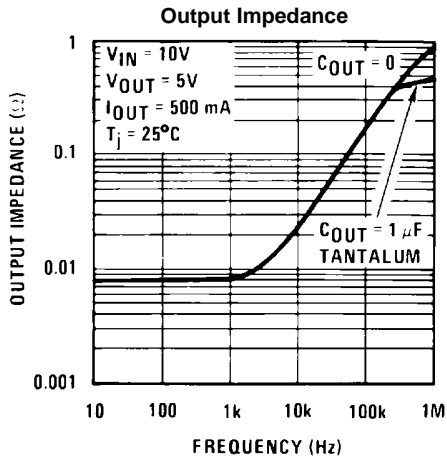

Figure 8.



TYPICAL PERFORMANCE CHARACTERISTICS (continued)



REVISION HISTORY

Changes from Revision C (April 2013) to Revision D	Page
• Changed layout of National Data Sheet to TI format	6

PACKAGING INFORMATION

Orderable Device	Status (1)	Package Type	Package Drawing	Pins	Package Qty	Eco Plan (2)	Lead/Ball Finish (6)	MSL Peak Temp (3)	Op Temp (°C)	Device Marking (4/5)	Samples
LM7805CT	ACTIVE	TO-220	NDE	3	45	TBD	Call TI	Call TI	0 to 70	LM340T5 7805 P+	
LM7805CT/NOPB	ACTIVE	TO-220	NDE	3	45	Pb-Free (RoHS Exempt)	CU SN	Level-1-NA-UNLIM	0 to 70	LM340T5 7805 P+	
LM7815CT	NRND	TO-220	NDE	3	45	TBD	Call TI	Call TI	0 to 70	LM340T15 7815 P+	
LM7815CT/NOPB	ACTIVE	TO-220	NDE	3	45	Green (RoHS & no Sb/Br)	CU SN	Level-1-NA-UNLIM	0 to 70	LM340T15 7815 P+	

(1) The marketing status values are defined as follows:

ACTIVE: Product device recommended for new designs.

LIFEBUY: TI has announced that the device will be discontinued, and a lifetime-buy period is in effect.

NRND: Not recommended for new designs. Device is in production to support existing customers, but TI does not recommend using this part in a new design.

PREVIEW: Device has been announced but is not in production. Samples may or may not be available.

OBSELETE: TI has discontinued the production of the device.

(2) Eco Plan - The planned eco-friendly classification: Pb-Free (RoHS), Pb-Free (RoHS Exempt), or Green (RoHS & no Sb/Br) - please check <http://www.ti.com/productcontent> for the latest availability information and additional product content details.

TBD: The Pb-Free/Green conversion plan has not been defined.

Pb-Free (RoHS): TI's terms "Lead-Free" or "Pb-Free" mean semiconductor products that are compatible with the current RoHS requirements for all 6 substances, including the requirement that lead not exceed 0.1% by weight in homogeneous materials. Where designed to be soldered at high temperatures, TI Pb-Free products are suitable for use in specified lead-free processes.

Pb-Free (RoHS Exempt): This component has a RoHS exemption for either 1) lead-based flip-chip solder bumps used between the die and package, or 2) lead-based die adhesive used between the die and leadframe. The component is otherwise considered Pb-Free (RoHS compatible) as defined above.

Green (RoHS & no Sb/Br): TI defines "Green" to mean Pb-Free (RoHS compatible), and free of Bromine (Br) and Antimony (Sb) based flame retardants (Br or Sb do not exceed 0.1% by weight in homogeneous material)

(3) MSL, Peak Temp. - The Moisture Sensitivity Level rating according to the JEDEC industry standard classifications, and peak solder temperature.

(4) There may be additional marking, which relates to the logo, the lot trace code information, or the environmental category on the device.

(5) Multiple Device Markings will be inside parentheses. Only one Device Marking contained in parentheses and separated by a "~" will appear on a device. If a line is indented then it is a continuation of the previous line and the two combined represent the entire Device Marking for that device.

(6) Lead/Ball Finish - Orderable Devices may have multiple material finish options. Finish options are separated by a vertical ruled line. Lead/Ball Finish values may wrap to two lines if the finish value exceeds the maximum column width.

Important Information and Disclaimer: The information provided on this page represents TI's knowledge and belief as of the date that it is provided. TI bases its knowledge and belief on information provided by third parties, and makes no representation or warranty as to the accuracy of such information. Efforts are underway to better integrate information from third parties. TI has taken and continues to take reasonable steps to provide representative and accurate information but may not have conducted destructive testing or chemical analysis on incoming materials and chemicals. TI and TI suppliers consider certain information to be proprietary, and thus CAS numbers and other limited information may not be available for release.

In no event shall TI's liability arising out of such information exceed the total purchase price of the TI part(s) at issue in this document sold by TI to Customer on an annual basis.

NDE0003B



IMPORTANT NOTICE

Texas Instruments Incorporated and its subsidiaries (TI) reserve the right to make corrections, enhancements, improvements and other changes to its semiconductor products and services per JESD46, latest issue, and to discontinue any product or service per JESD48, latest issue. Buyers should obtain the latest relevant information before placing orders and should verify that such information is current and complete. All semiconductor products (also referred to herein as "components") are sold subject to TI's terms and conditions of sale supplied at the time of order acknowledgment.

TI warrants performance of its components to the specifications applicable at the time of sale, in accordance with the warranty in TI's terms and conditions of sale of semiconductor products. Testing and other quality control techniques are used to the extent TI deems necessary to support this warranty. Except where mandated by applicable law, testing of all parameters of each component is not necessarily performed.

TI assumes no liability for applications assistance or the design of Buyers' products. Buyers are responsible for their products and applications using TI components. To minimize the risks associated with Buyers' products and applications, Buyers should provide adequate design and operating safeguards.

TI does not warrant or represent that any license, either express or implied, is granted under any patent right, copyright, mask work right, or other intellectual property right relating to any combination, machine, or process in which TI components or services are used. Information published by TI regarding third-party products or services does not constitute a license to use such products or services or a warranty or endorsement thereof. Use of such information may require a license from a third party under the patents or other intellectual property of the third party, or a license from TI under the patents or other intellectual property of TI.

Reproduction of significant portions of TI information in TI data books or data sheets is permissible only if reproduction is without alteration and is accompanied by all associated warranties, conditions, limitations, and notices. TI is not responsible or liable for such altered documentation. Information of third parties may be subject to additional restrictions.

Resale of TI components or services with statements different from or beyond the parameters stated by TI for that component or service voids all express and any implied warranties for the associated TI component or service and is an unfair and deceptive business practice. TI is not responsible or liable for any such statements.

Buyer acknowledges and agrees that it is solely responsible for compliance with all legal, regulatory and safety-related requirements concerning its products, and any use of TI components in its applications, notwithstanding any applications-related information or support that may be provided by TI. Buyer represents and agrees that it has all the necessary expertise to create and implement safeguards which anticipate dangerous consequences of failures, monitor failures and their consequences, lessen the likelihood of failures that might cause harm and take appropriate remedial actions. Buyer will fully indemnify TI and its representatives against any damages arising out of the use of any TI components in safety-critical applications.

In some cases, TI components may be promoted specifically to facilitate safety-related applications. With such components, TI's goal is to help enable customers to design and create their own end-product solutions that meet applicable functional safety standards and requirements. Nonetheless, such components are subject to these terms.

No TI components are authorized for use in FDA Class III (or similar life-critical medical equipment) unless authorized officers of the parties have executed a special agreement specifically governing such use.

Only those TI components which TI has specifically designated as military grade or "enhanced plastic" are designed and intended for use in military/aerospace applications or environments. Buyer acknowledges and agrees that any military or aerospace use of TI components which have **not** been so designated is solely at the Buyer's risk, and that Buyer is solely responsible for compliance with all legal and regulatory requirements in connection with such use.

TI has specifically designated certain components as meeting ISO/TS16949 requirements, mainly for automotive use. In any case of use of non-designated products, TI will not be responsible for any failure to meet ISO/TS16949.

Products

Audio	www.ti.com/audio
Amplifiers	amplifier.ti.com
Data Converters	dataconverter.ti.com
DLP® Products	www.dlp.com
DSP	dsp.ti.com
Clocks and Timers	www.ti.com/clocks
Interface	interface.ti.com
Logic	logic.ti.com
Power Mgmt	power.ti.com
Microcontrollers	microcontroller.ti.com
RFID	www.ti-rfid.com
OMAP Applications Processors	www.ti.com/omap
Wireless Connectivity	www.ti.com/wirelessconnectivity

Applications

Automotive and Transportation	www.ti.com/automotive
Communications and Telecom	www.ti.com/communications
Computers and Peripherals	www.ti.com/computers
Consumer Electronics	www.ti.com/consumer-apps
Energy and Lighting	www.ti.com/energy
Industrial	www.ti.com/industrial
Medical	www.ti.com/medical
Security	www.ti.com/security
Space, Avionics and Defense	www.ti.com/space-avionics-defense
Video and Imaging	www.ti.com/video

TI E2E Community

e2e.ti.com